

# ELOK

## 705/707 & 715/717 User Manual



# E-LOK 7-Series

## Summary Check List:

For further details see pages 8-12

1. Crop out done as per template.

2. Arrow on spindle hub points to lever/hinges.

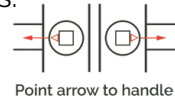

3. If changing handing, ensure plastic washers re-installed and fixing screw hand tightened.



4. Check rubber gasket installed correctly, with lugs pressed in tight, to ensure seal around backplate edge.

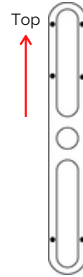

5. Ensure split pin is installed, securing spindle to spindle hub.



6. Ensure screw casing bolts and through bolts tightened.

7. Ensure power cable wire installed correctly and not bent or crimped in door.

8. Check batteries installed in correct position.

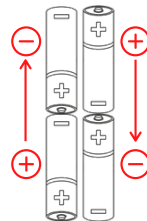

Professionally Installed by: \_\_\_\_\_

PIN code: \_\_\_\_\_

Date: \_\_\_/\_\_\_/\_\_\_

# E-LOK 7-Series

## Please Note:

- Keep the included mechanical keys in a convenient place such as an Elements Hardware 1336 Key Safe
- Replace the batteries when they have low voltage
- Read this User Manual carefully before installing your 7-Series Smart Lock



1336-BLK Shown

## Contents Page:

- Pg 4.** 7-Series Body Dimensions
- Pg 5.** Mortice Lock Options
- Pg 6.** 7-Series Packing List
- Pg 7.** 7-Series Specifications
- Pg 8.** Adjusting the Handing
- Pg 9.** Arrow on Spindle Hub
- Pg 10.** Installation: Steps 1-4
- Pg 11.** Installation: Steps 4-7
- Pg 12.** Factory Reset: If you're the admin
- Pg 13.** Factory Reset: Other methods
- Pg 14.** First Set-Up
- Pg 15.** Bluetooth Unlock + PIN Code Management
- Pg 16.** RFID Card Management + Fingerprint Management
- Pg 17.** Remote Unlock + e-Key Management
- Pg 18.** Admin Passcode + Unlock Records
- Pg 19.** Battery Percentage + Lockset Clock
- Pg 20.** Passage Mode
- Pg 21.** Extra Lock Settings 1
- Pg 22.** Extra Lock Settings 2
- Pg 23.** Extra Lock Settings 3
- Pg 24.** Extra Lock Settings 4
- Pg 25.** Transferring Lockset Ownership
- Pg 26.** Use of Master Admin, Admin + User Pg. 1
- Pg 27.** Use of Master Admin, Admin + User Pg. 2
- Pg 28.** Use of Master Admin, Admin + User Pg. 3
- Pg 29.** 7-Series Handle Functions
- Pg 30.** Unlock with Mechanical Key
- Pg 31.** E-LOK Gateway Pg. 1
- Pg 32.** E-LOK Gateway Pg. 2
- Pg 33.** E-LOK Gateway Pg. 3
- Pg 34.** E-LOK Gateway Reset, Transfer Ownership & Specs
- Pg 35.** Maintenance Guide
- Pg 36.** Important Notes
- Pg 37.** Contact

# E-LOK 7-Series

## 7-Series Body Dimensions:

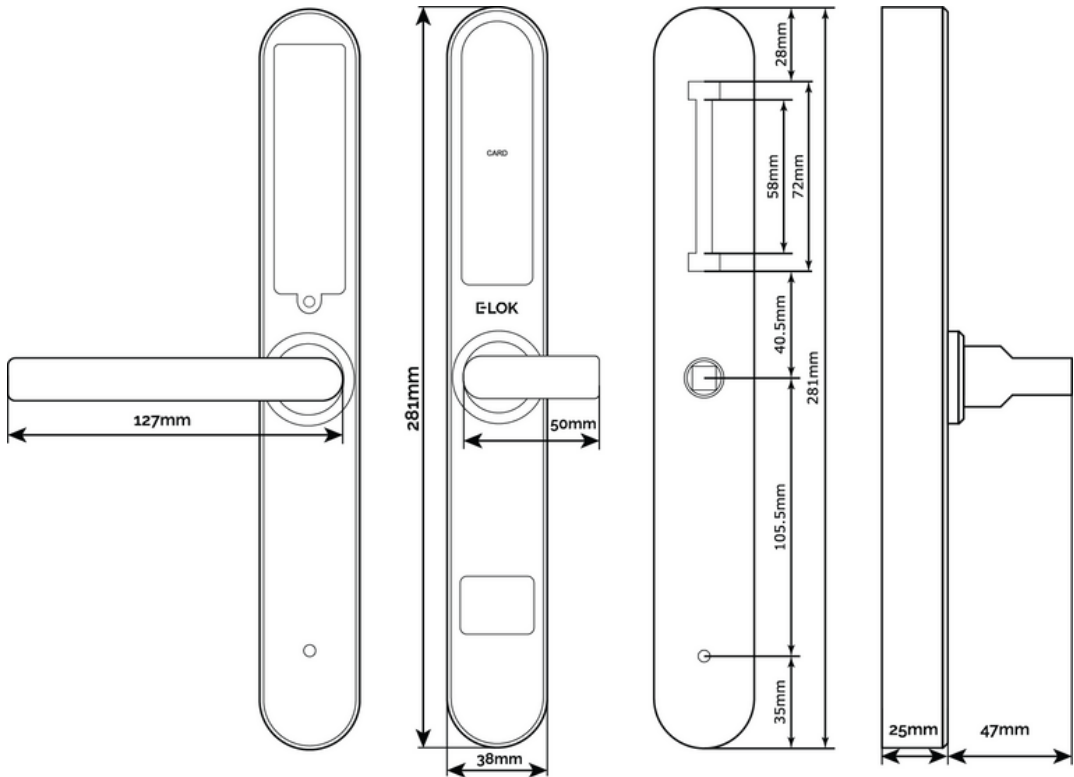

- 705 & 707 model shown on left with Standard Lever, rear panel
- 715 & 717 model shown in mid-left with Snib Lever, front panel
- Mounting points shown mid-right
- Body and lever projection shown on right

# E-LOK 7-Series

**Mortise Lock Options:** All Mortise templates are available online at E-LOK.com

**Back set:**

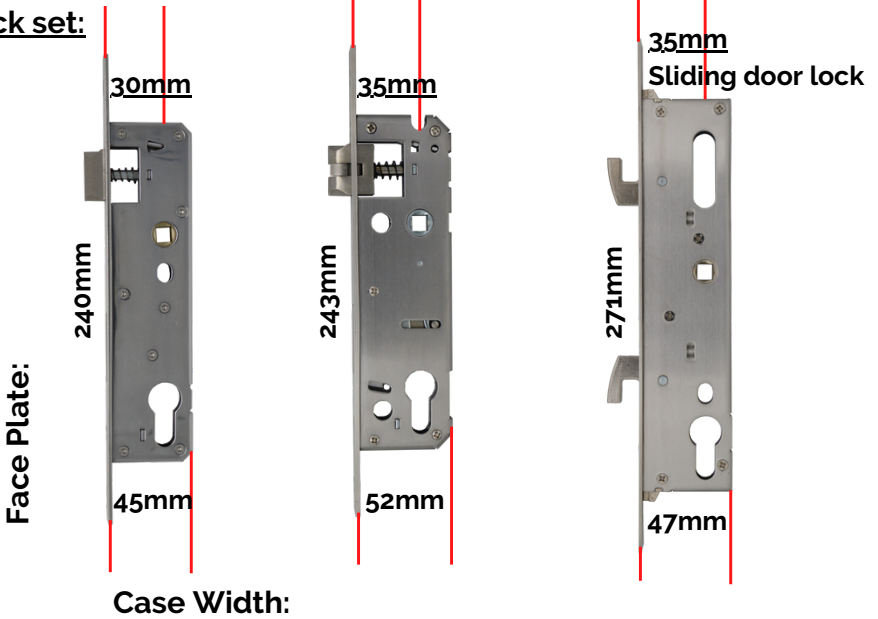

**Back set:**

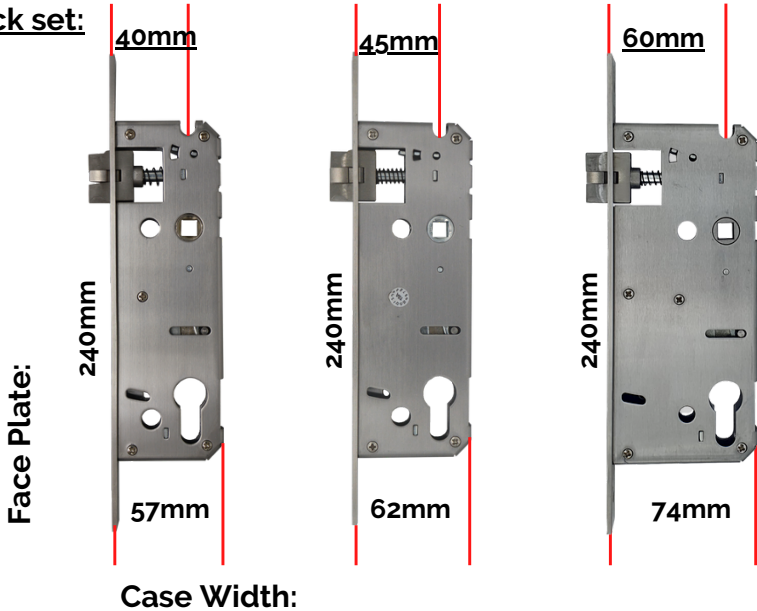

# E-LOK 7-Series

## 7-Series Packing List:

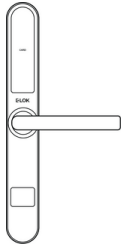

Front Panel  
QTY 1

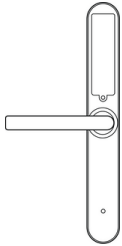

Back Panel  
QTY 1

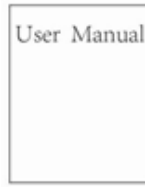

User Manual  
QTY 1



(not included  
with 705-0,  
707-0, 715-0  
& 717-0)

Mortice lock  
QTY 1



Faceplate &  
Striker Screw QTY 4



Mechanical Key  
QTY 2



RFID Card  
QTY 3



Split Pin  
QTY 1

For door  
thickness:  
30-50mm



Short Spindle  
QTY 1

For door  
thickness:  
50-80mm



Long Spindle  
QTY 1

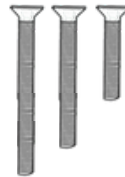

Fixing Screws 1  
QTY 3



Screw Casing  
QTY 2



Gasket  
QTY 2



Sliding Screw  
QTY 2



Fixing Screws 2  
QTY 2



Gateway  
(Optional)

# E-LOK 7-Series

## Specifications:

<b>Product Name:</b>	E-LOK 7-Series Smart Lock
<b>Operating Application:</b>	E-LOK App
<b>Manufactured Material:</b>	304 Stainless Steel
<b>Finish Styles:</b>	Electroplate Black, Stainless Steel
<b>Unlock Methods:</b>	PIN Code RFID Card E-LOK App Mechanical Key Fingerprint (707 and 717 Models Only)
<b>Max Num. Locks on App:</b>	Unlimited
<b>Max Num. PIN Codes:</b>	200 PIN codes
<b>Max Num. RFID Cards:</b>	200 RFID Cards
<b>Max Num. Fingerprints:</b>	200 Fingerprints
<b>Batteries:</b>	6V (4 x AAA Batteries) - Must be Alkaline
<b>Battery life:</b>	5,000 Lock and Unlock Operations
<b>Operating Temp:</b>	-20°C - 70°C
<b>Operating Humidity:</b>	10% - 95%
<b>Suitable Door Thickness:</b>	30mm - 80mm
<b>Suitable Door Types:</b>	Aluminium Door, Wooden Door
<b>Product Size:</b>	280mm(H) x38mm(W) x25mm(D)
<b>Available Mortice lock Sizes:</b>	30, 35, 40, 45, 60mm Back Set and 35mm Sliding Lock
<b>7-Series Residential Warranty:</b>	2 Year Mechanical & Electrical
<b>E-LOK Gateway Warranty:</b>	2 Year
<b>Weather Rating:</b>	IP 55 (705 and 715 Models Only)



# E-LOK 7-Series

## Adjusting the Handing:

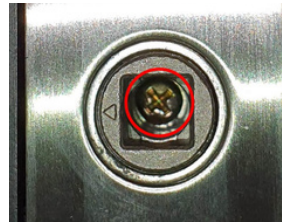
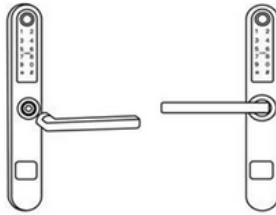
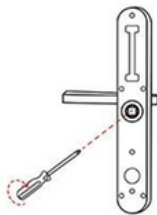

Location of screw shown:

To turn the handing on the front panel, loosen the inner screw.

Remove the handle.

After adjusting the direction of the handle, insert it into the handle seat, re-tighten the inner screw and ensure arrow is pointing in the direction of the handle (above image).

Check the inner-screw is tight before moving onto the rear panel.

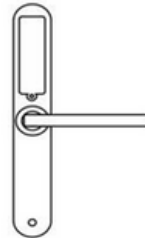
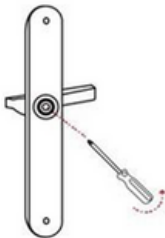

Complete the same process for the rear handle. Ensure inner screw is tight when re-attaching handle to the panel. It is recommended to apply Loctite to the handle screw.

To reverse the Mortice Lock:

- Turn lock upside down
- Push latch into lock case
- Holding latch in lock case, turn 180 degrees
- Release latch to full extended position

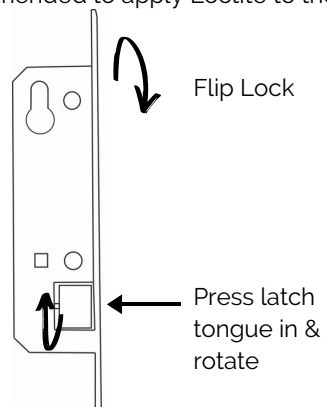

## Arrow on Spindle Hub & Split Pin:

The arrow on the spindle hub must point in the direction of the handle (point in direction of hinges)

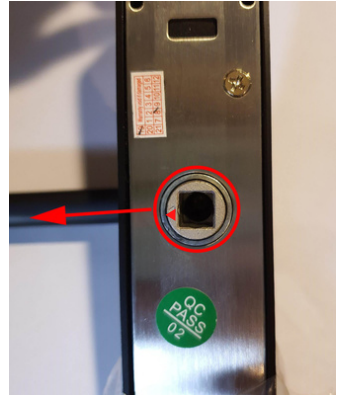
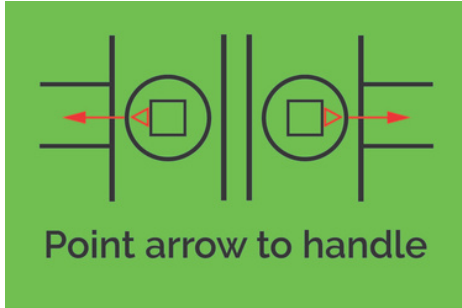

**If this step is missed and the arrow is pointing:**

**Upwards:** Whilst outside, the deadbolt won't throw when lever is lifted up.

**Opposite:** The E-LOK will appear to stay unlocked permanently.

If you are experiencing these symptoms please ensure the arrow alignment is correct + split pin is installed.

**If your E-LOK was working fine for 4-12 weeks and now won't open from the outside, the Split Pin may have not been installed. To test:**

Open door from inside, lift the inside handle up, check if deadbolt has thrown. Holding the outside handle, lift the outside handle up, check if deadbolt has thrown. If the deadbolt throws with the inside handle and not the outside handle, the Split Pin was not installed.

# E-LOK 7-Series

## Installation:

### Step 1.

If you are retrofitting into an existing mortice hole, this step may not be required. If you are fitting the 7-Series into a new hole, take the included mortice template and cut the holes into your door. Your E-LOK 7-Series comes with screws to suit both wooden and aluminium doors.

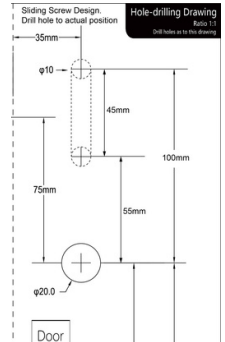
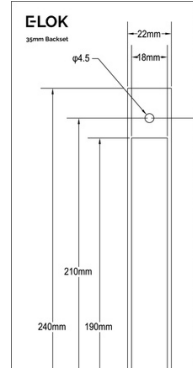

### Step 2.

On the door face, you'll be required to make holes to suit the top screw, spindle and bottom screw of the E-LOK Smart Lock. Note the top fixing screw is adjustable. Please cut to actual screw position.

### Step 3.

Install the mortice lock into the door. Ensure fixings are tight and straight.

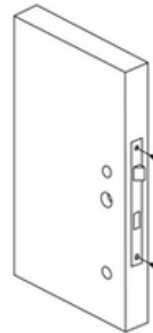

### Step 4.

Install the spindle into the outdoor handle. Ensure that before you install, check the arrow is pointing in the direction of the handle. Use the included split pin to secure spindle in place,

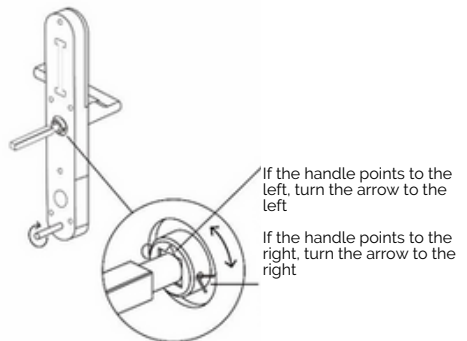

## Installation:

### Step 5.

Now install the adjustable height screw casing on the outdoor handle and bottom screw casing. Now attach the included rubber gaskets to both the front and back handle.

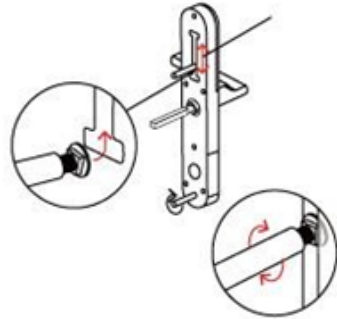

### Step 6.

Now you are ready to connect the front and back panel. Remove the battery case from the back panel. Connect the cable, ensure there is space in the door for it. You may have to create a cavity in a wooden door for this.

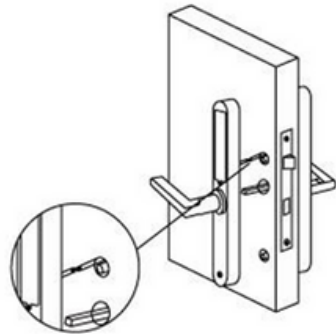

### Step 7.

Screw the back panel to front. Depending on your door width, use the appropriate included fixings screws for the top and bottom fixing points.

Install Batteries and screw the battery case back into place.

E-LOK 7-Series Smart Lock should be ready to go!

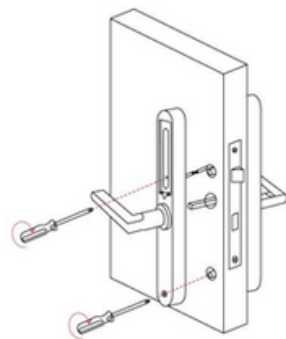

# E-LOK 7-Series

## Factory Reset: (if you are admin and in Bluetooth range)

### Normal Factory Reset:

You must be admin and in Bluetooth range of the Smart Lock in order to complete factory reset.

You can factory reset your E-LOK by going into the lock settings and tapping "Delete".

This will fully factory reset the E-LOK Smart Lock.

From here, you can set the E-LOK Smart Lock back up to your phone.

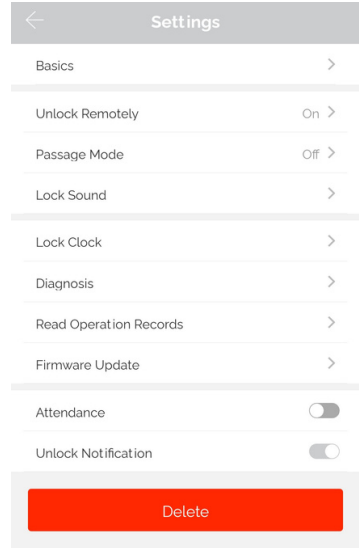

# E-LOK 7-Series

## Factory Reset (if you are not admin):

### Manual reset:

If you are not admin of the E-LOK Smart Lock, remove battery cover and complete:

Long press the button on the bottom left side in battery case for 5 seconds or until you hear "Please input initialisation passcode". Now input code "000#" on the keypad.

The system reset will be complete. From here you can link the E-LOK Smart Lock to your phone.



### Trouble shooting:

If you manual reset whilst you were admin of the E-LOK, transferring Lockset to Trash will complete the reset of the E-LOK:

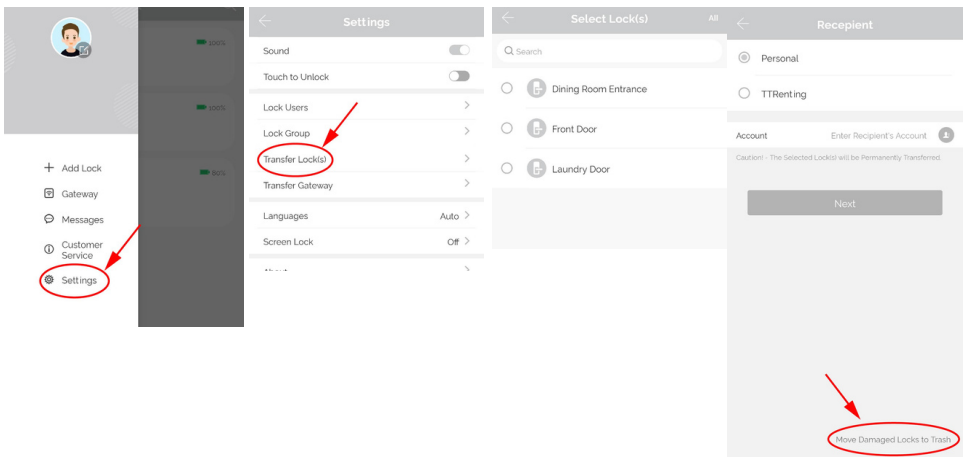

# E-LOK 7-Series

## First Set-Up:

Get the E-LOK App by visiting [E-LOK.com](http://E-LOK.com) for the app download link

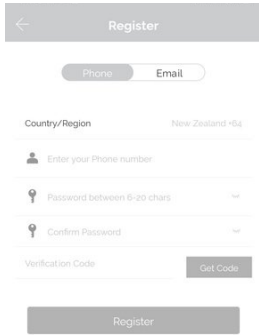

1. Register an account with E-LOK using either phone number or email.

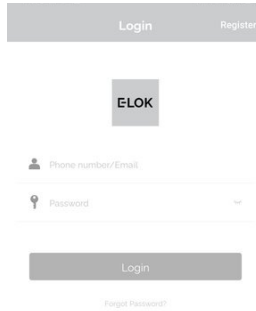

2. Login to your account.

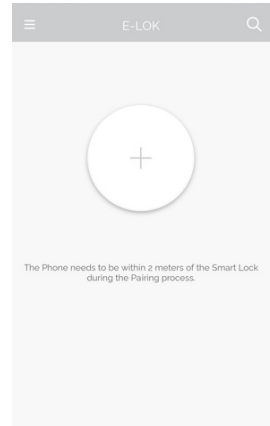

3. Ensure E-LOK 7-Series is on and Bluetooth enabled on phone, connect to lock. Tap pinpad & + sign to pair

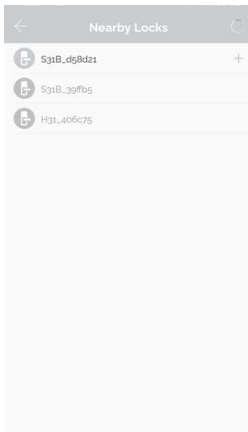

4. Select your E-LOK 7-Series. Note it will not be called the model of your E-LOK Smart Lock.

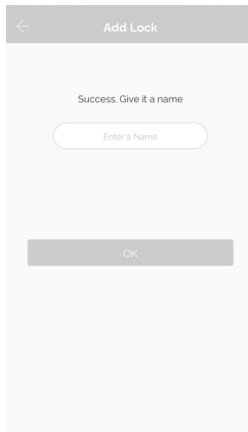

5. Rename your E-LOK 7-Series to your preference.

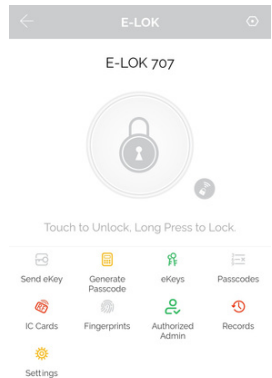

6. View your E-LOK lock management page.

## Bluetooth Unlock + PIN Code Management

### Bluetooth Unlock:

After you've connected your phone to your E-LOK Smart Lock, open the lock management page and tap the "Unlock" icon. This will unlock your Smart Lock via Bluetooth and it will automatically re-lock itself according to the set auto lock timer.

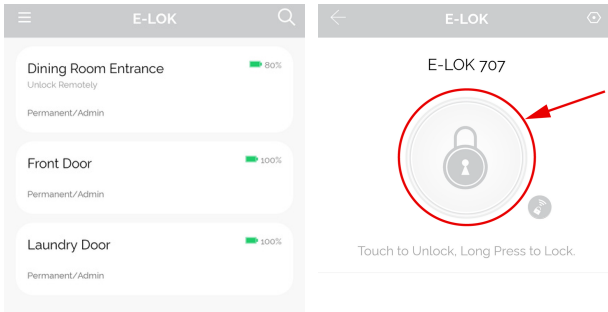

### PIN code Management:

E-LOK App allows you to set 200 unique PIN Codes. You can set a range of different types of PIN Code. The best is to choose 'Custom' to create yours. Set it to permanent, name it and set your preferred sequence. (4-9 digits).

Recurring PIN Code allows you to set a PIN Code that only works on certain times and days. Either set the PIN Code to work one day a week, daily, weekdays or weekends -during set hours. The app also allows for one-timed and timed PIN Codes.

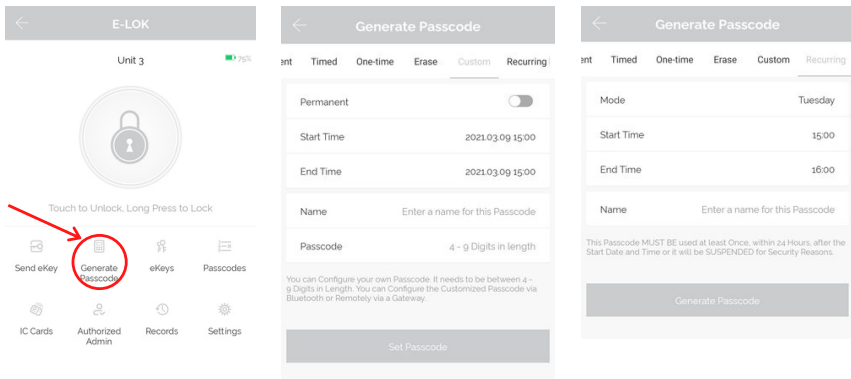



# E-LOK 7-Series

## RFID Card + Fingerprint Management

### RFID Card Management:

E-LOK App allows you to store 200 unique RFID Cards. To set up one of the three included with your E-LOK 7-Series Smart Lock, tap "Cards" on the lock management page, tap "Add Card", name your RFID Card, and then sync to your E-LOK Smart Lock.

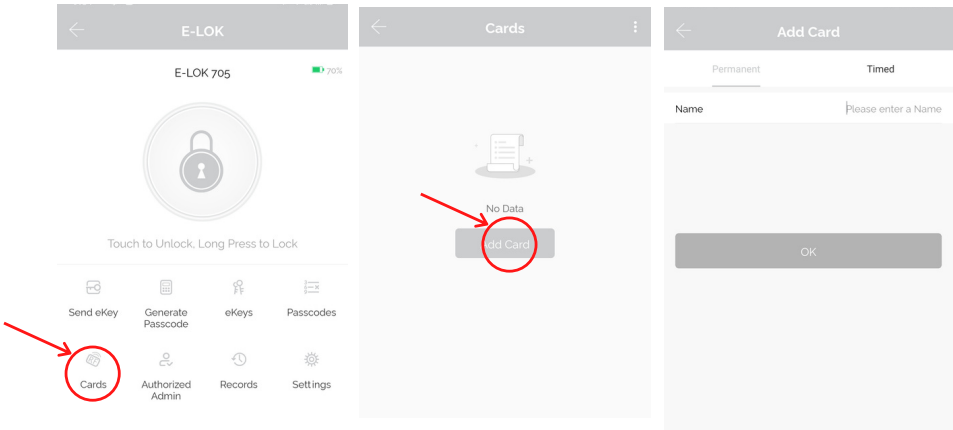

### Fingerprint Management (707 and 717 Models Only):

E-LOK App allows you to store 200 separate fingerprints to unlock your Smart Lock. To add your fingerprint tap "Fingerprints", tap the top right menu and "Add Fingerprint". From here you can name and manage when the fingerprint will unlock your Smart Lock. Tap "Next" and follow the prompts to add your fingerprint to your Smart Lock.

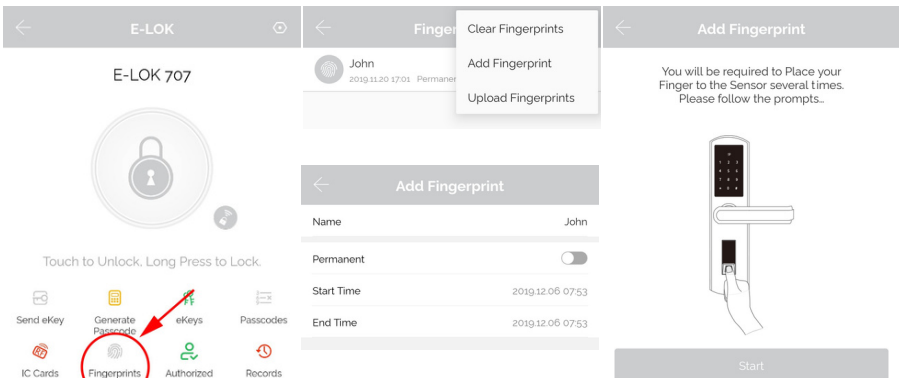

# E-LOK 7-Series

## Remote Unlock + e-Key Management

### Remote Wi-Fi Unlock (only with E-LOK Gateway Add-on).

After you've connected your phone to your E-LOK Smart Lock and connected your E-LOK Gateway, open the lock management page and ensure Unlock Remotely is enabled in the settings. Now tap the Unlock icon. This will unlock your E-LOK via Wi-Fi and it will automatically re-lock itself.

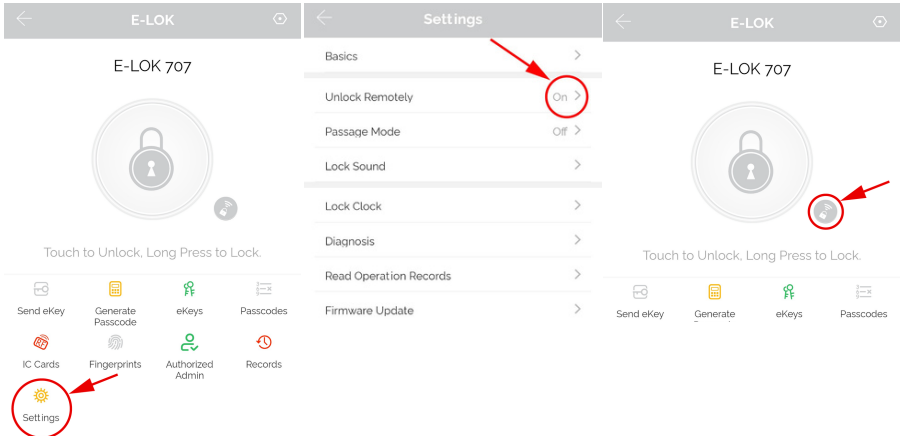

### e-Key Management:

An e-Key gives another person with an E-LOK App Account access to view and use your E-LOK 7-Series. Tap on the "eKey" icon on the lock management page. This allows you to send an electronic key to another person with an E-LOK App account. You can either set the account to be an Admin or a User. Check the Master Admin page for further information on how to use e-Keys.

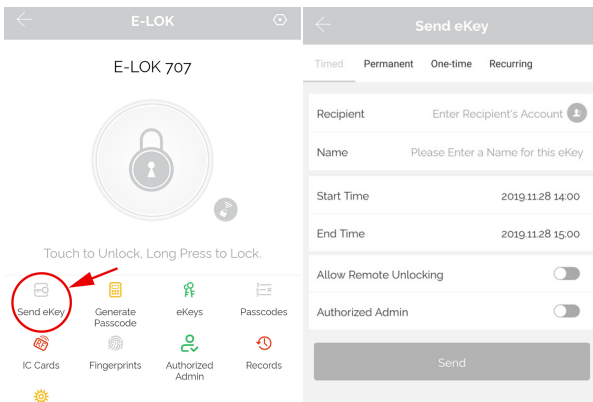

## Admin Passcode + Unlock Records

### Admin Passcode:

E-LOK comes with an admin passcode. To view this tap "Settings" on the lock management page, tap "Basics" and then tap "Admin Passcode". Keep a note of this passcode.

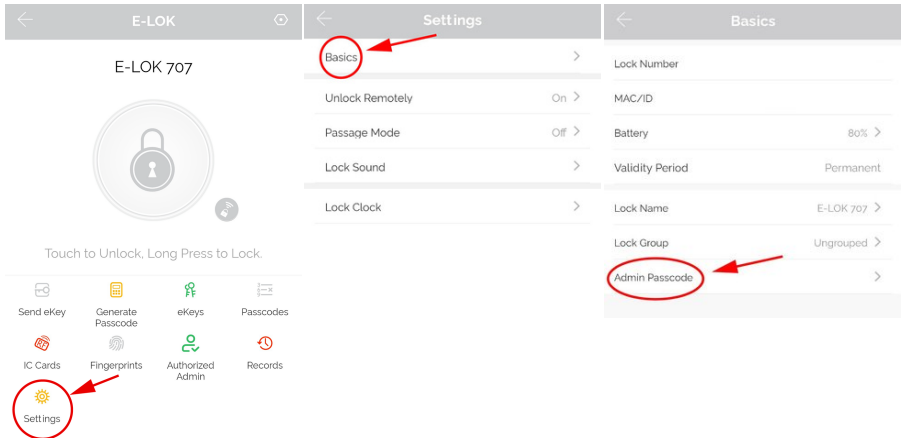

### Unlock Records:

E-LOK App records which passcodes were used to unlock the E-LOK and when. You can view these records by going into the "Records" menu on the lock management page. In the example you can see the name of the unlock code, eg "John", what time it was used and what type of unlock code was used. With App versions 1.2 and above, you can view failed unlock attempts and see which code was used.

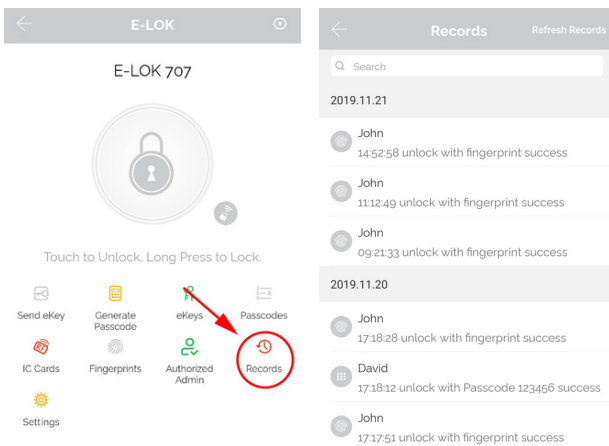

## Battery Percentage + Lockset Clock:

### Check Battery Percentage:

E-LOK App allows you to check the battery percentage of your E-LOK in two easy ways. In the lock select page, the app will give you a percentage overview to the nearest 5%. You can also find a more accurate battery level in the settings of the Smart Lock. Tap into "Settings", then "Basics" and then view your battery percentage.

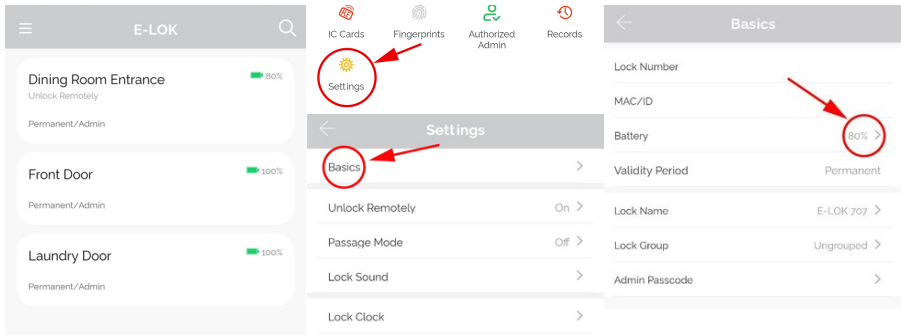

### E-LOK Lockset Clock:

For the unlock records to be synched correctly, the Lockset clock needs to be calibrated. To do this, Tap into "Settings" then "Lock Clock". Here tap "Calibrate Time". Your E-LOK Smart Lock will communicate with the E-LOK App and set the correct time. This will ensure the operation/unlock records are accurate.

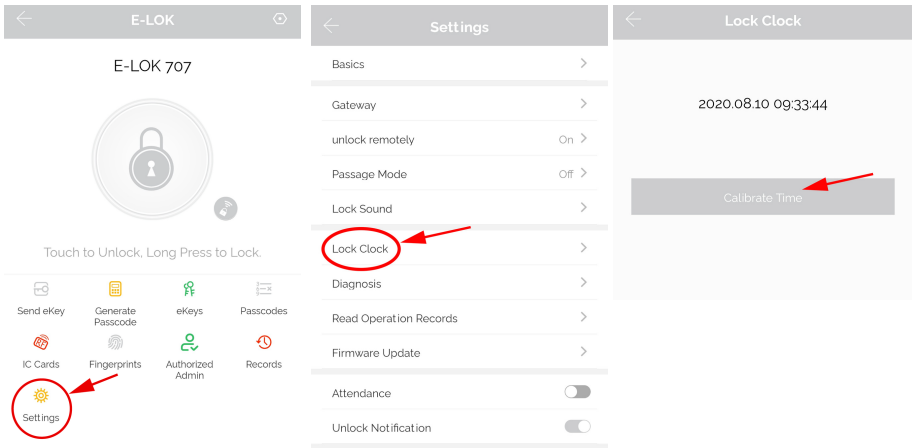

# E-LOK 7-Series

## Passage Mode:

### Passage Mode:

E-LOK App allows you to manage and control passage mode on your E-LOK 7-Series Smart Lock. Tap into "Settings", "Passage Mode", then choose the days and hours you want your E-LOK Smart Lock to be in passage mode. A common application for this is having a Smart Lock on passage mode Mon-Fri 9am-5pm for an office building. As a security feature, passage mode only begins after an unlock method (pincode, RFID Card etc) has been used on the smart lock.

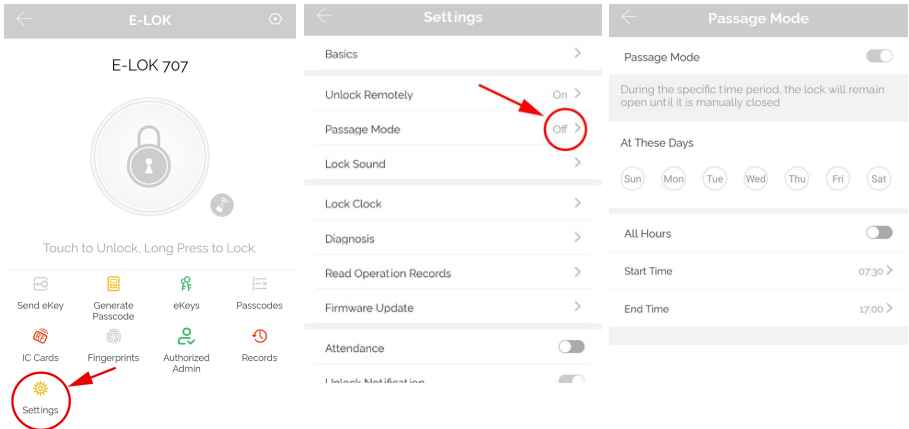

When you leave your house or office with passage mode set on, there are two methods to lock your E-LOK Smart Lock correctly:

Open up the E-LOK App, long press "Lock" button on E-LOK app. This will Lock your Smart Lock until you unlock it with pinpad, fingerprint, RFID Card Etc. Ensure you lift handle to engage bolt.

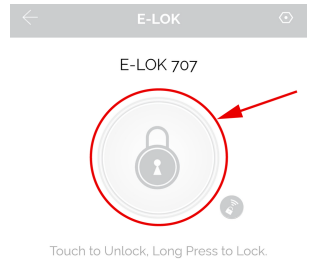

Once exited, long press "#" Key on pinpad. This will lock the E-LOK Smart Lock until you unlock it again. This method is perfect as it doesn't require the use of a phone. Ensure you lift handle and engage bolt.

To unlock the E-LOK Smart Lock again, please use preferred unlock method, eg Pinpad, RFID FOB, App or Fingerprint (707 and 717 Models Only).



## Extra Smart Lock Settings:

### Auto Lock:

E-LOK App allows you to adjust the auto lock timer on the Smart Lock. This is the timer that is triggered once the Smart Lock has been unlocked using any unlock method unless passage mode is enabled. Auto lock timer is under the lock settings tab.

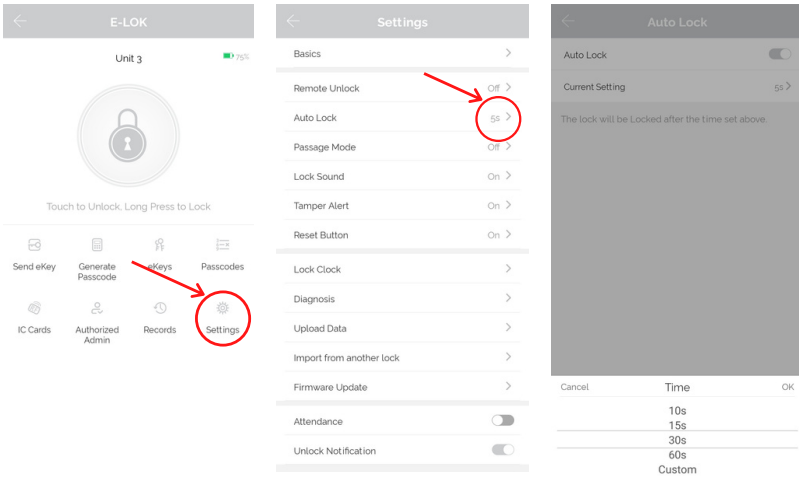

### Lock Sound:

Lock Sound setting lets you enable or disable the sound coming from the smart lock when you, unlock, lock, set passage mode etc. By default Lock Sound is enabled.

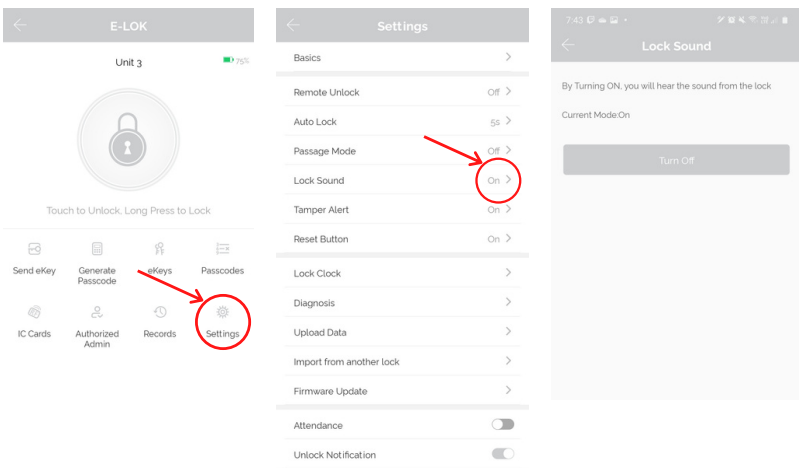

## Extra Smart Lock Settings:

### Reset Button:

With E-LOK App, you can enable or disable the factory reset button inside the battery case. Disabling this reset button will prevent someone from resetting the E-LOK Smart Lock and locking you out (apart from mechanical key). This feature works great on E-LOK's installed on Airbnb's, rentals etc.

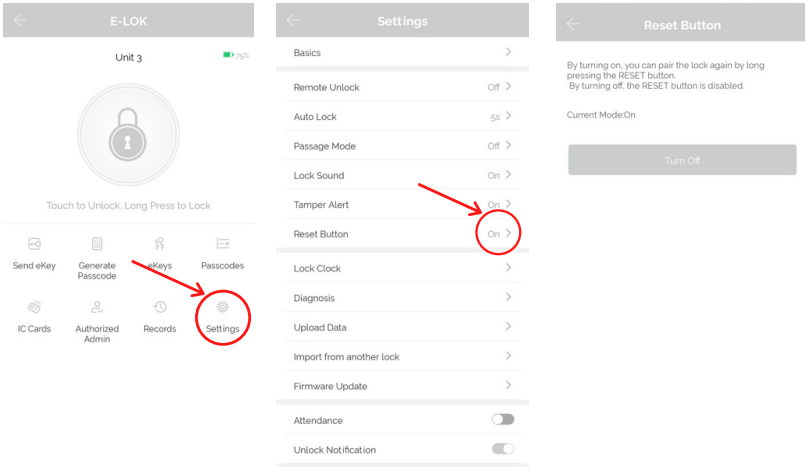

### Tamper Alert:

By default, after multiple failed unlock attempts, the E-LOK smart lock will sound a Tamper Alert. You can disable or enable this feature in the app settings as shown below: Tamper Alert locks out the E-LOK on a timer and sounds an alarm.

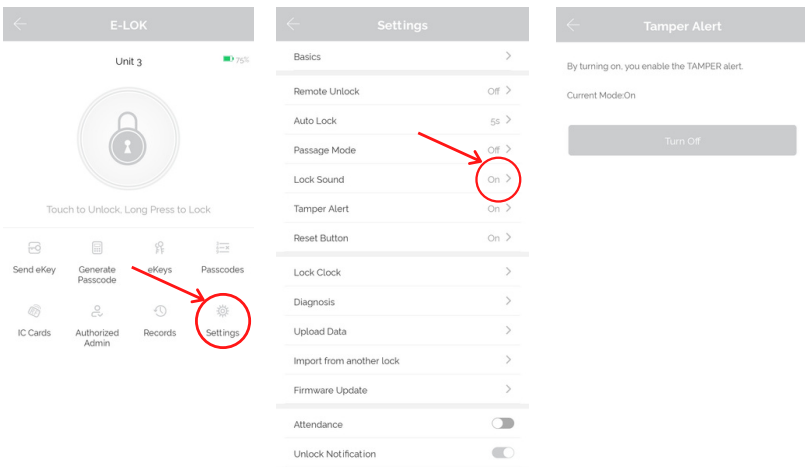

## Extra Smart Lock Settings:

### Import from another E-LOK Smart Lock:

Import from another app feature allows you to sync PIN-Codes and RFID Cards between E-LOK Smart locks. If you have more than one E-LOK Smart Lock use this feature to have your PIN Code and RFID Card to work on each, without setting them up again. This feature is in the lock settings.

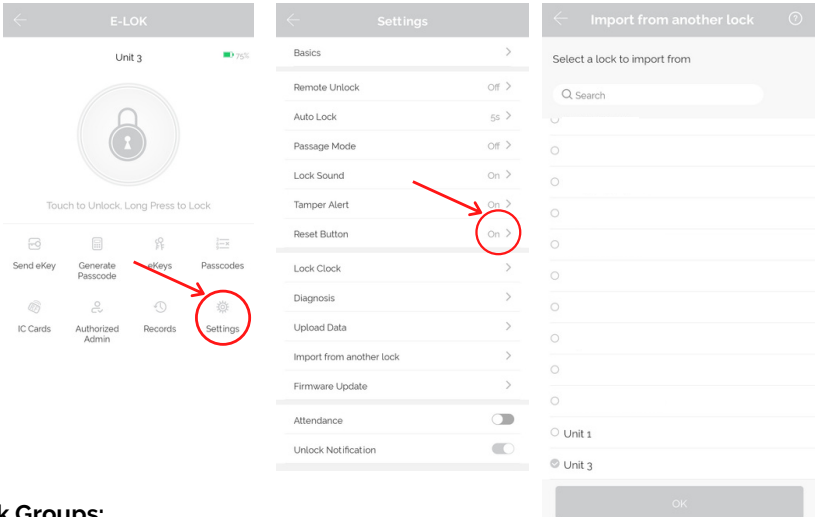

### Lock Groups:

You can link E-LOK Smart Locks together in lock groups. First create a lock group in the main settings, then link a Smart Lock to the group in the lock settings. View lock groups in the select page.

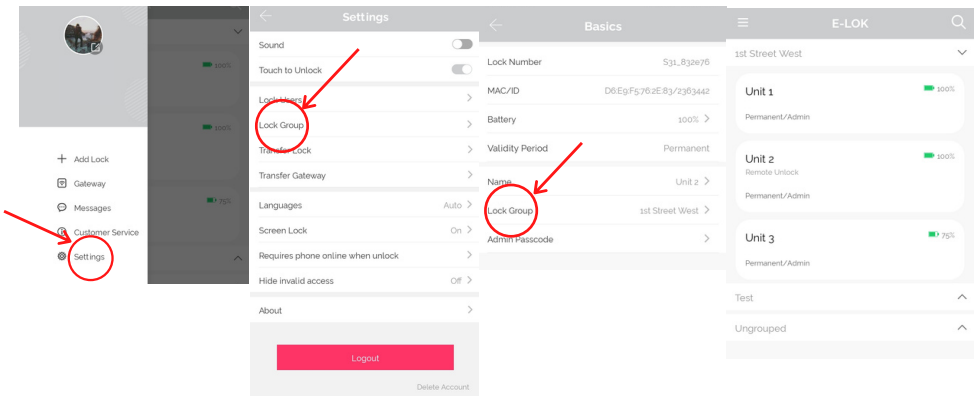



## Extra Smart Lock Settings:

### Proximity Touch to unlock:

Proximity touch to unlock when enabled lets you unlock your E-LOK Smart Lock just by pressing any number on the Keypad. To use this feature, enable "Touch to Unlock" in the settings tab, have your app open to your E-LOK, then press any number on the Keypad.

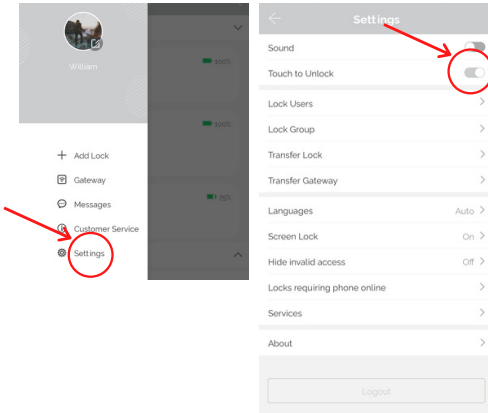

## Transfer Lockset Ownership:

Transferring Lockset ownership can be useful in a few scenarios. What it allows you to do is give Master Admin ownership to another E-LOK App account holder. The process to Transfer Lockset Ownership is shown below:

Tap into "Settings" then into "Transfer Lock(s)". Here you can select the Smart Locks you wish to transfer ownership. You will then be required to input the receiving account's email or phone number (whichever the E-LOK App account was created with). A confirmation code will be sent to your contact detail (either phone or email). Once the confirmation code is inputted, the Smart Lock ownership will be transferred to that account.

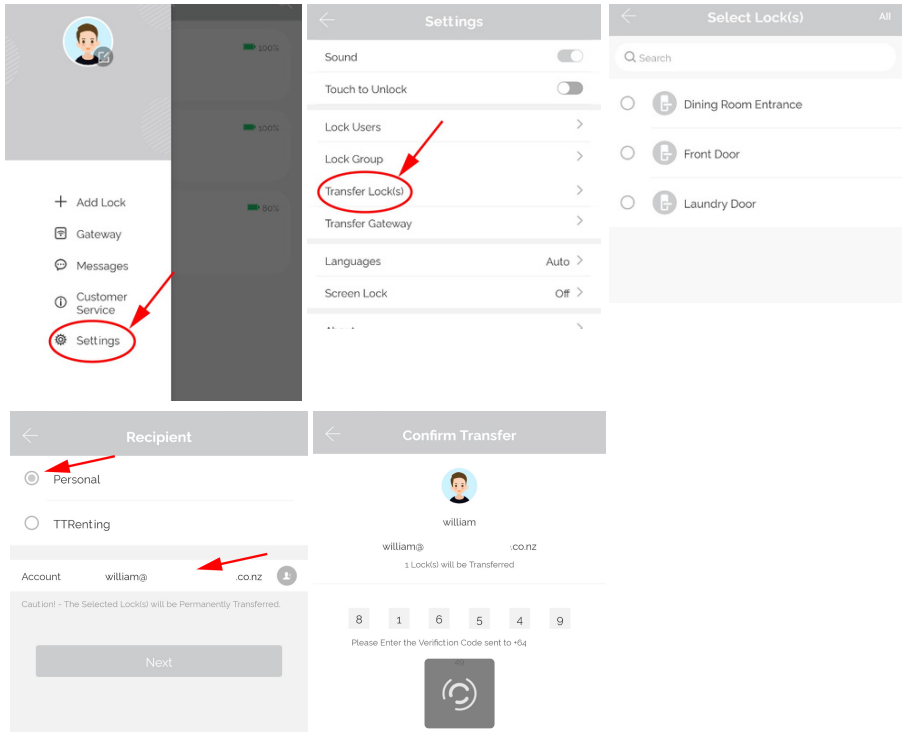

### NOTE:

Transferring Lockset Ownership retains any and all PIN-Codes, RFID Cards, Fingerprints and settings previously programmed to that specific E-LOK Smart Lock.

# E-LOK 7-Series

## Use of Master Admin + Admin & User

### Using Master Admin, Admin and User functions via eKey

E-LOK app allows you to distribute specific usage rights to other E-LOK app account holders. This function allows you to set up another admin for your Smart Lock, or set up a user for your Smart Lock. This means other users will be able to view your lock management page, unlock via Bluetooth and if they're an admin, add new unlock codes.

Here's how it works:

If you are the account holder that **originally** set-up your E-LOK 7-Series Smart Lock, then your account is automatically considered the **Master Admin** for that lock set. You cannot change who the **Master Admin** is, unless you reset the E-LOK Smart Lock or Transfer Lockset Ownership (shown page 25). A Master Admin can send an eKey to new Admin or simply create a User. Master Admin, Admin and Users are a part of a permissions hierarchy and each have their own rules in place.

Below is the permissions hierarchy chart for Master Admins, Admins and Users:



- There can only be one **MASTER ADMIN** per Smart Lock. (This is the account that originally sets up the Smart Lock).
- There can be multiple Admins and Users.
- An Admin can set-up a User but not another Admin.
- A Master Admin can set up both Admins and Users.
- A Master Admin can receive notifications when Smart Lock is unlocked,

# E-LOK 7-Series

## Use of Admin + User Functions Continued

### Other important notes with the Master Admin, Admin and User Hierarchy:

#### Master Admin:

The Master Admin can see all passcodes associated with its particular Smart Lock. The Master Admin can see which Admin created a passcode, when and at what time it was created. The Master Admin can also see when a particular passcode was used and also delete them from being used again.

#### Admin:

An Admin can set passcodes for their chosen 7-Series Smart Lock. They can only view their own passcodes and none of the passcodes set by another Admin or the Master Admin.

#### User:

A User only has the permission to unlock the Smart Lock Via Bluetooth or remotely via Wi-Fi if enabled. User's have no power to change or alter any unlock codes or settings with your E-LOK 7-Series.

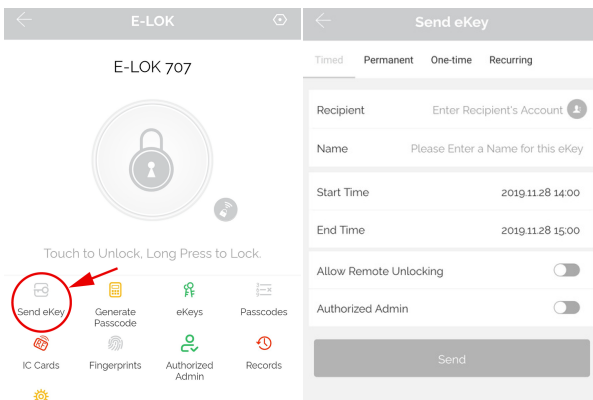

## Use of Admin + User Functions Continued

### Example Application of Master Admin, Admin & User Function:

A great practical use of the Master Admin and Admin feature is with property management.

Here's how it works best:

Property Manager: Master Admin

Property Owner: Admin

Cleaner: Admin or User

Tenant: User

The **Property Manager** (Master Admin) can remotely monitor and control the Smart Lock (with E-LOK Gateway) on behalf of the **Property Owner**. They can add, delete and name separate unlock codes and allocate them for use by different Admins or Users. This allows the **Property Manager** to seamlessly manage and monitor tenants, clients and cleaners with ease. When tenants change, or clients leave, **Property Managers** can simply revoke their account access to unlock the lock set and delete any unlock codes the tenant or client used.

The **Property Owner** (Admin) can add, change or delete unlock codes set by themselves. This means that can make unlock codes and assign them by name to a client or tenant and delete them when circumstances change. As an Admin the **Property Owner** cannot change or view unlock codes that have been set by the **Property Manager** (Master Admin). This set-up is ideal if the **Property Owner** is not located near the property itself.

**Cleaners, Clients** and **Tenants** can be set up with User accounts if they choose to create an E-LOK App account. This would allow them to unlock the Smart Lock via Bluetooth or remotely over Wi-Fi (not advisable due to obvious security reasons). It is easiest for an Admin or Master Admin to create an unlock code and name associate the unlock code with the person. For the **Property Manager** they'll be able to read and monitor the unlock records of the Smart Lock and delete codes as **Tenants/Clients** change or leave.

# E-LOK 7-Series

## Using E-LOK 7-Series Smart Lock



Your E-LOK 7-Series Smart Lock has two handle functions:

Lift up the handle to engage the mortice deadbolt.

Pull down to unlock and release latch + deadbolt

Important Notes: When the E-LOK 7-Series automatically locks, the handle disengages from the latch, but you can still lift the handle to engage the mortice bolt.

# E-LOK 7-Series

## Unlocking E-LOK 7-Series with Key

Your E-LOK comes with three mechanical keys and a slot in the front panel to use them. If you've forgotten your PIN Code or your E-LOK 7-Series batteries are flat, follow these steps to unlock it mechanically.

Press your finger into left or right side of cover, which should lever open.  
Insert key to key slot.

Turn the key to shown position

Pull the handle down as it is now engaged with the latch.

If batteries are flat please replace them.



Shown on the right is the location of the mechanical key barrel, with cover removed.

The Micro USB port beside it can be used to power up the Smart Lock if the batteries fail. When connected to a power bank or battery source, the Smart Lock can be powered up and then a PIN Code, RFID Card or the app can be used to unlock it.



# E-LOK 7-Series

## E-LOK Gateway (only if you've purchased the E-LOK Gateway Add-On)

E-LOK Gateway allows you to transfer information and commands to your 7-Series E-LOK via Wi-Fi. It also allows you to change settings, unlock the 7-Series and receive live notifications when it is unlocked and which passcode was used.

Please note: only the **Master Admin** can set-up an E-LOK Gateway for a Smart Lock.

E-LOK Gateway should be plugged in via the included USB-C cable.

It must be:

- Near a Wi-Fi router
- Near the E-LOK 7-Series

If the E-LOK Gateway is not near one or both, connection may be poor and the E-LOK Gateway may not function as expected.

### To add the E-LOK Gateway to the E-LOK App follows these steps:

Open the left menu on the E-LOK App. Tap "Gateway". Tap "+" Sign. Select "G2"

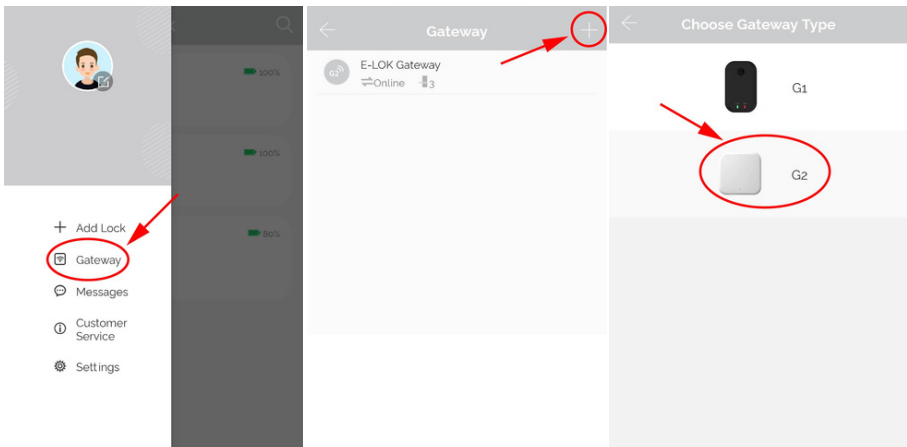



# E-LOK 7-Series

## E-LOK Gateway (only if you've purchased the E-LOK Gateway Add-On)

Plug in E-LOK Gateway. The light should flash red and blue - this means its ready to connect.

Tap "Next" then Tap "G2"

Configure your network (2.4GHz only), input Wi-Fi password and name the E-LOK Gateway.

This will have your E-LOK Gateway set-up on your home network and linked into the app and your 7-Series Smart Lock.

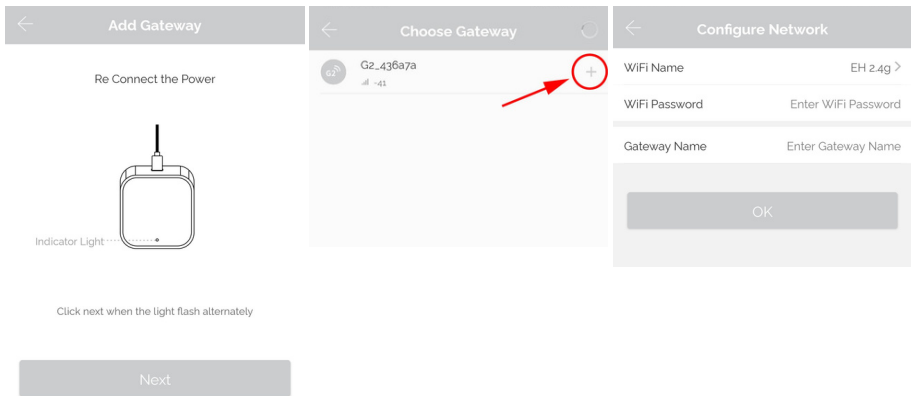

The E-LOK Gateway will now scan for an E-LOK 7-Series to connect to. This process takes a short amount of time. Once the scan is complete, it will display your E-LOK 7-Series and its connection to the Gateway. You can have multiple E-LOK 7-Series connected to one E-LOK Gateway.

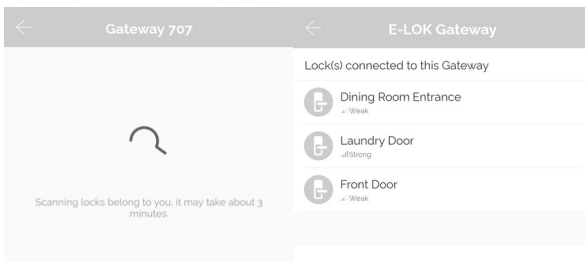

# E-LOK 7-Series

## E-LOK Gateway (only if you've purchased the E-LOK Gateway Add-On)

Last step is to ensure the Unlock Remotely feature is enabled on your 7-Series. Open your lock management, tap into "Settings", locate the "Unlock Remotely" menu and ensure this is enabled.

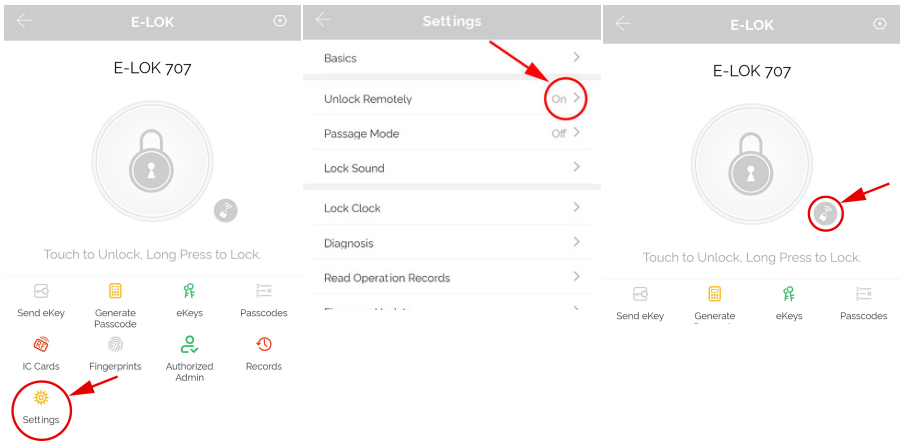

You will now be able to control your E-LOK 7-Series from the app remotely via Wi-Fi, whether you're at work or out-of-town. You can add, change or delete unlock codes. The remote unlock feature will now be available. You can also receive live notifications for when your E-LOK 7-Series was unlocked, and which code was used to unlock it.

If the E-LOK Gateway refuses to connect or displays error messages; disconnect it from the power source for at least 15 minutes. Then retry setting it up,

## E-LOK Gateway Specs + other info

### Reset E-LOK Gateway:

If you require factory reset your E-LOK Gateway follow the below process. Removing the Gateway from your app will unlink the Smart Locks that are connected to it. The Smart Locks will work as usual via Bluetooth.

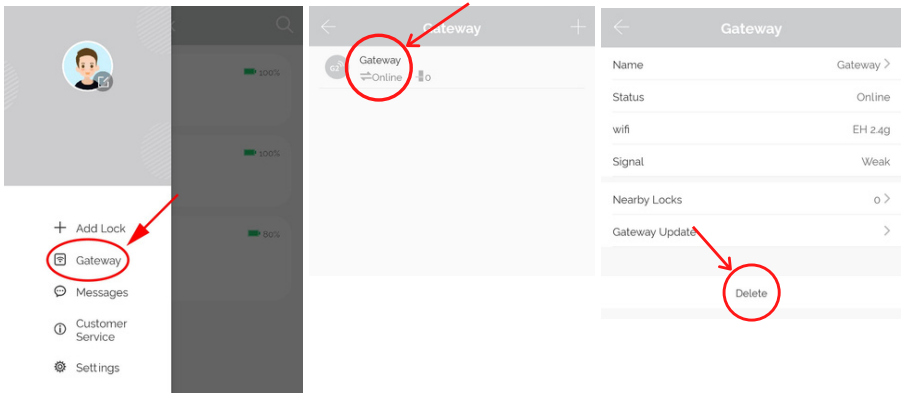

### Transfer Gateway:

Similar to Transferring Lockset ownership, you can transfer the ownership of Gateway's setup on your account. Steps below show process. Once transferred, you will no longer have access to that Gateway.

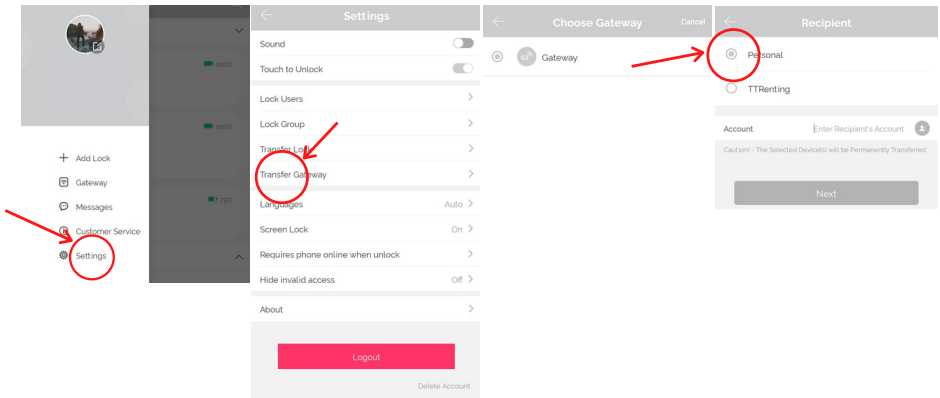

### Additional Gateway Specs:

Network: 2.4 GHz  
IEEE Standard: 802.11b/g/n  
Power Interface: Type-C USB  
Power Input: DC5V/500mA

## Maintenance Guide:

Maintenance should be carried out on your E-LOK 7-Series every 6 months.

Use the below guide to ensure your lock set lasts the test of time:

### Every 6 months:

- Check that the screws fixing the mortice lock are tight. Check that the screws fixing the rear panel to the front panel are tight.
- Check if batteries need replacing. If battery percentage is low replace with four fresh Alkaline 1.5V AAA batteries.
- Wipe the surface of the E-LOK 7-Series Smart Lock with a cloth dampened with only water. This will help remove any dust or micro contaminants from the surface.
- If the handle feels loose or wiggles from the Smart Lock, you may have to remove the Smart Lock from the door and re-tighten the inner screw with Loctite securing the handle to either or both the front and rear panel.
- It is also a good idea to do a full factory reset of the E-LOK 7-Series Smart Lock to ensure software stays light and un-bloated.

## Important Notes:

Please Note:

You must use the E-LOK App to set-up your E-LOK 7-Series Smart Lock. When you first power up your E-LOK, the Smart Lock will be unusable until you have completed the short set-up process and added at least one unlock code. You can find a link to the app on [E-LOK.com](http://E-LOK.com)

The E-LOK App allows you to manage an unlimited amount of E-LOK Smart Locks from your phone. Remember to name each E-LOK Smart Lock uniquely to ensure you don't mix them up.

The E-LOK Gateway can connect to multiple E-LOK Smart Locks. An instance where you'd need multiple E-LOK Gateway's is if one E-LOK Smart Lock is on a different site or only in range of a different Wi-Fi network.

The E-LOK App allows you to manage multiple E-LOK Gateways with their individually connected E-LOK Smart Locks. This means you can have an E-LOK Gateway at home connected to your E-LOK 7-Series Smart Lock plus one at work and manage them individually.

## Contact:

If you run into trouble with your E-LOK Smart Lock please visit: [E-LOK.com](http://E-LOK.com) for further information, help and tools. If you don't find your answer on [E-LOK.com](http://E-LOK.com) use the contact box and send us an email.

You can also email us direct, by going into the Customer Service menu on the E-LOK App.

# ELOK 7-Series

**Notes:**

# ELOK

# 7 - Series

## User Manual

E-LOK.com

Version: 2110 E7UM